

**NEW**  
Product  
**LAUNCH**

# AI-20

## THE FOURTH GENERATION TRUNK LINE OPTICAL FIBER FUSION SPLICER

*Built-in high precision*

***Delay return electric one-step fiber cleaver***



Accurate of fiber alignment :0.1 $\mu$ m

# Full link integration design

## Highly integrated

The AI-20, the fourth generation fiber fusion splicer developed by Signal fire, is the latest generation of fiber fusion splicer designed for full link integration. It combines Signal fire's latest research and development of a delayed return electric one-step cleaver with fiber fusion splicing, while integrating OPM and VFL functions. Combined with a nine in one signalfire fiber stripper, a combinable workbench and worktable, it truly becomes a compact, lightweight, and easy to operate fiber fusion splicer, which will greatly improve your work efficiency.



SIX MOTORS

FIBER CORE  
ALIGNMENT

6S SPLICING



15S HEATING

WITHIN OPM  
FUNCTIONWITHIN VFL  
FUNCTIONDELAY RETURN ELECTRIC  
ONE-STEP FIBER CLEAVERSIGNAL FIRE  
STRIPPER

# Humanized design meets different Construction environments



Compact and portable



Climbing high is also easy



Bench+support platform



Can be used as a bench



Host support /protection console



Equipped with signal fire stripper



Signal fire AI-20 fusion splicer applies multiple of the latest patented technologies of Signal fire, and adopts a more advanced central processing unit, more advanced algorithms, and higher precision cameras. The weight of bare machine, tool case and complete set of accessories only 4.5kg, size of tool case is 25.5cmx16.5cmx23cm. In such a compact and compact situation, the combination design of workbench and bench has been achieved simultaneously. 1 second startup, 6 seconds rapid fusion, 15 seconds heating, 5-inch color high-definition LCD screen, 320x magnification, 7800mAh large capacity lithium battery can fuse and heat 240 cores, still performs well in harsh environments such as high altitude, dry, and cold.

# Exquisite craftsmanship High standard design



## The buttons are clear and beautiful

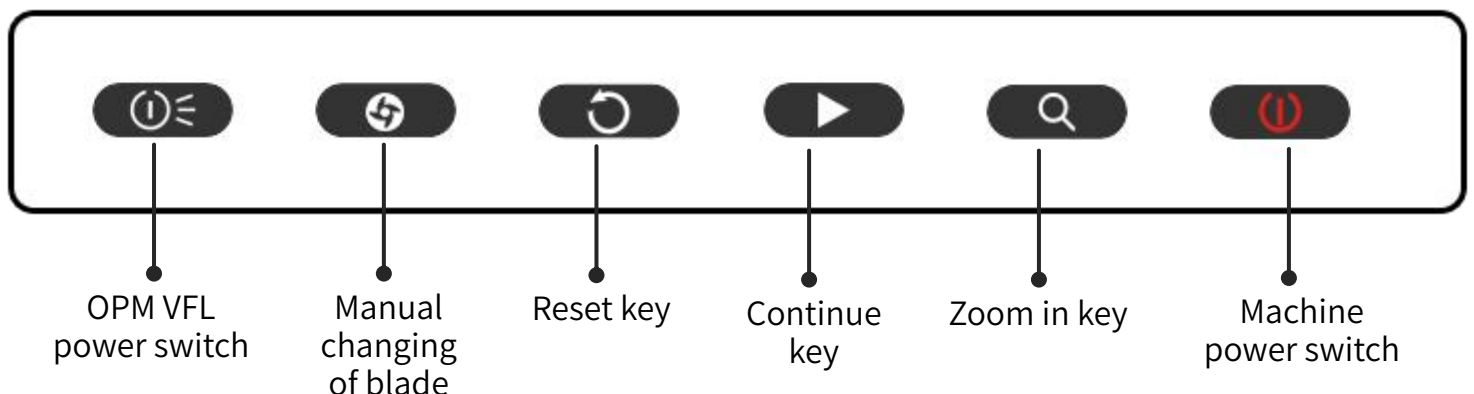

# Display 5 inch TFT color display screen

320X (X or Y axis single display) 200X (X and Y axis dual display)

The screenshot shows a 5-inch TFT color display screen with the following labeled elements:

- X screen display:** Shows '15:11' and 'X'.
- Left and right angle:** Indicated by a red line pointing to the top horizontal fiber image.
- Left end face angle:** Indicated by a red line pointing to the left end of the fiber image.
- Y screen display:** Shows 'Y'.
- Fiber mode:** Shows 'SM' for both fibers.
- Fiber optic image amplification:** Indicated by a red line pointing to the fiber image.
- Fiber status remind:** Indicated by a red line pointing to the bottom status bar.
- Smart tips:** Indicated by a red line pointing to the bottom status bar.
- Heating time:** Shows '15S'.
- Remaining electricity:** Shows '70%'.
- Bluetooth:** Indicated by a Bluetooth icon.
- Right end face angle:** Indicated by a red line pointing to the right end of the fiber image.
- Splicing loss:** Shows '0.00dB'.
- Total splicing:** Shows 'Remain: 888' and 'Total: 2112'.

A red arrow points from the 'Smart tips' label to a red warning icon in the bottom status bar, which is labeled **Fault intelligent judgment reminder**.



Camera failure



Core align failed



Focus failed



ARC calibration failed



Left and right fiber does not match



The lens is foggy or foreign body interference

# Built-in high precision delay return electric one-step fiber cleaver



Signal fire new generation fiber fusion splicer has significantly reduced the actual weight and volume of the entire equipment by reducing auxiliary tools and improving the automation level, ultimately achieving a true improvement in fusion quality and efficiency. This is the fourth generation fiber fusion splicer that we first launched, and the core is full link integration design, highly integrated.

# Blades surface automatically manually change delayed cleaver return

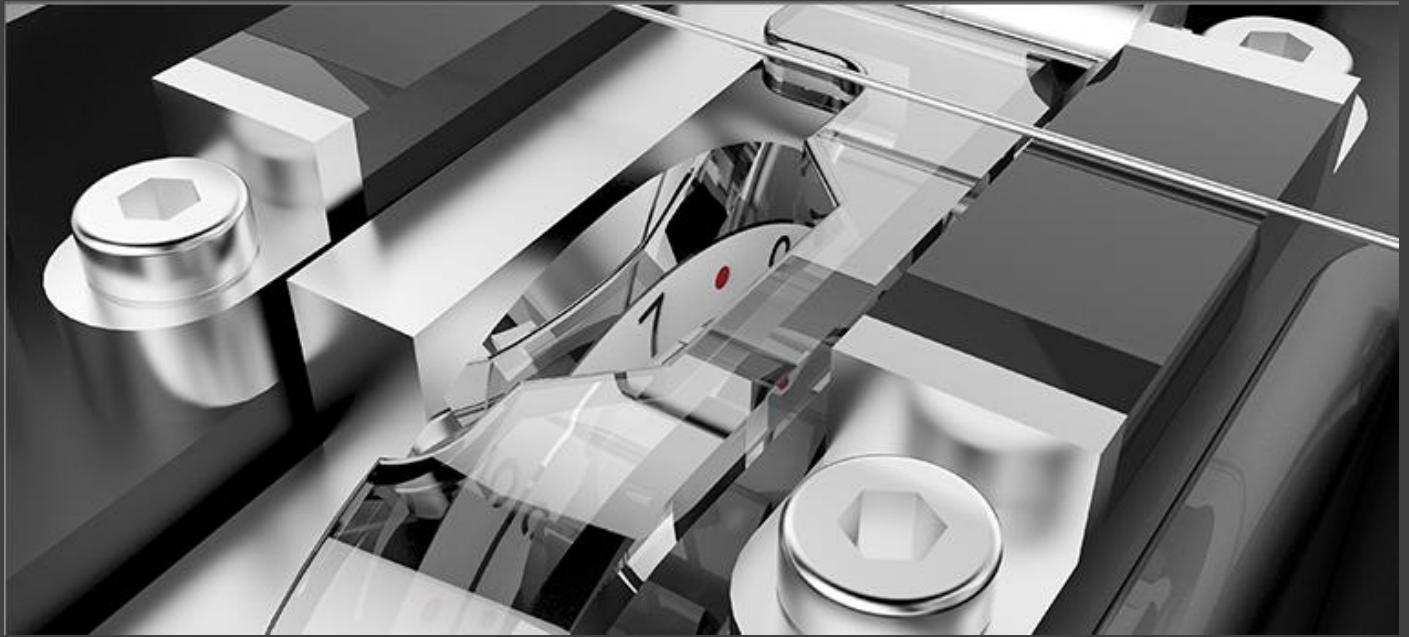

## AUTOMATIC CHANGE

Cleaver blades surface automatically change when the current cutting point cut fiber more than 1000 times and continuously shown three times unqualified cutting results.

## MANUAL CHANGE

Manual button operation, cleaver blades surface will change. Cleaver has 24 cutting points in total, current cutting point cut numbers, blades total cut numbers, Available within the APP.



## AUTOMATIC DELAYED CLEAVER RETURN

Perfectly solves the problem of traditional mechanical one-step cleaver back cutting scratching the fiber end face. The factory standard delay time is set to 0.5 seconds, and the adjustable range is 0.2 seconds to 2 seconds.

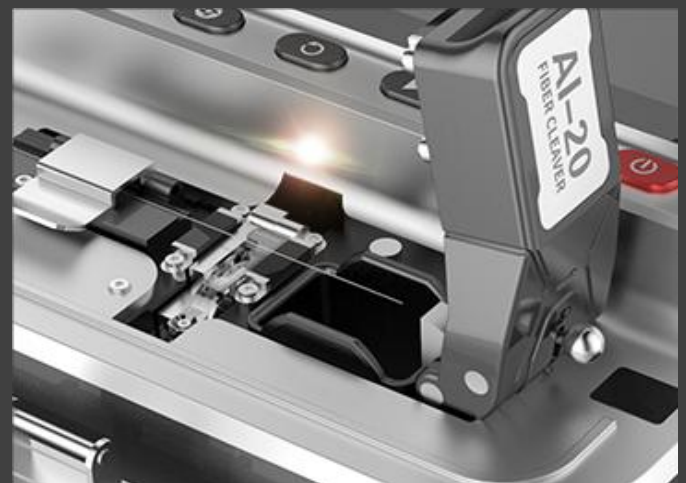

## CLEAVER LED AUXILIARY LIGHTING

Brightness can be adjusted through APP.



# APP Bluetooth connection

< System parameters Save

Blade change stroke  Value range 10 ~ 100

Cutter face change stroke  Value range 10 ~ 100

Cutting speed  Value range 1~5

Return blade delay  ms Value range 200 ~ 2000ms

Blade usage details and rotating blade face >

Replace the blade >

How to adjust blade height >

LED brightness adjustment 

< cutter setting

Total number of cuts 12598

Number of times the current blade has been used: 2610

Current point: 5

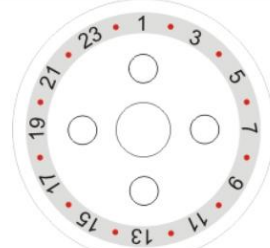

# Built-in VFL and OPM function

Measure fiber link loss/luminous flux  
Fiber line tracking, breakpoint/light leakage detection



**OPM**(Measurement range: -50+30dbm)

**VFL**(10km)

**OPM**

**Switch between ten states**

Wavelength: 850nm、1300nm、1310nm  
1490nm、1550nm、1625nm、980nm  
1270nm、1577nm、1650nm

**VFL**

**Switch between three states**

power: 15mW, 2Hz flashing and steady on mode

# Real-time luminous flux assisted alignment

Only applicable to environments with stable optical signal link from front

Intelligently analyze the alignment point with the lowest splicing loss and then splice the fiber

Splicing is completed

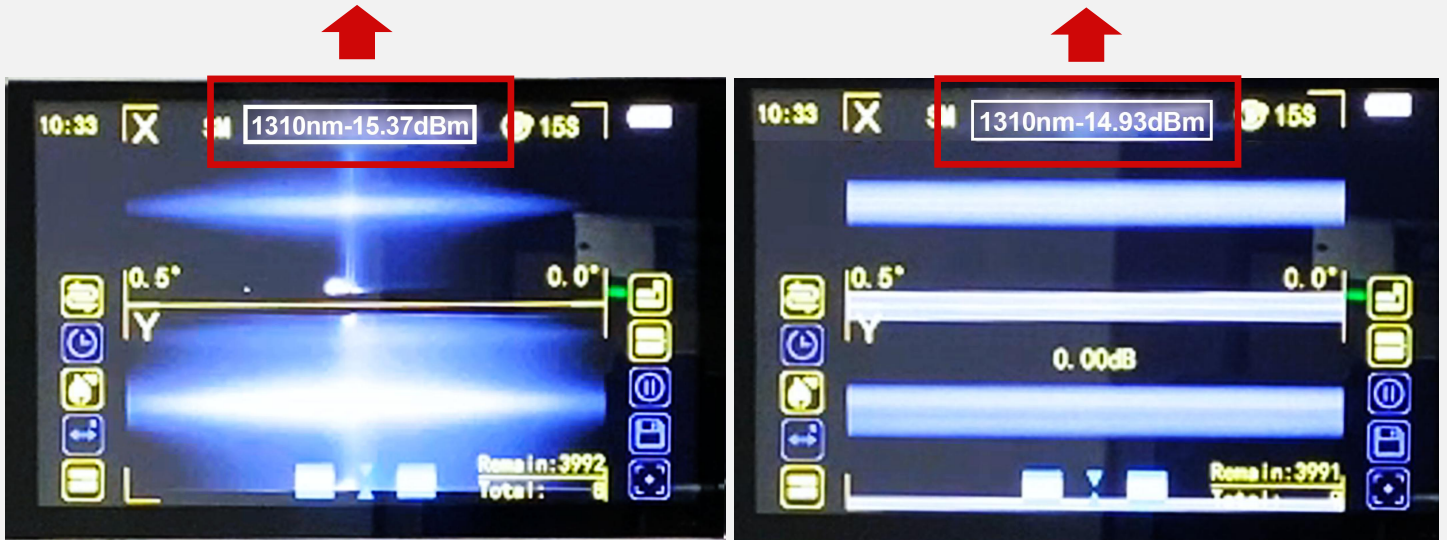

Real-time luminous flux assisted alignment technology developed by Signalfire, which intelligently analyzes the alignment point with the least loss to minimize the fiber fusion loss.

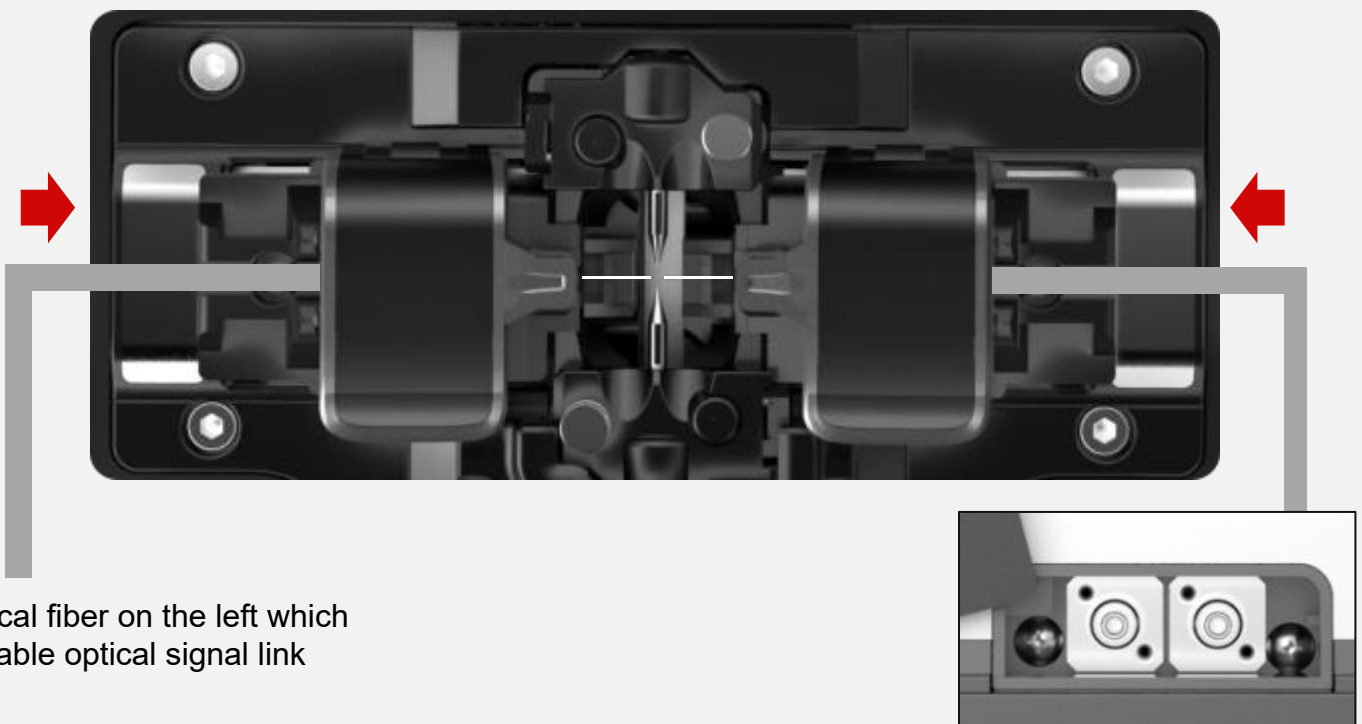

Optical fiber on the left which is stable optical signal link

Optical Fiber on the right with fast connector which has plugged to OPM Port

# Equipped with signal fire stripper



## A GOOD STRIPPER NINE FUNCTIONS

- kevlar scissors
- Three-port Miller stripper
- 5G FTTH Drop cable
- Both regular FTTH Drop cable
- FTTH Drop cable steel wire pliers
- Rotary ruler
- Cleaning cotton

# Signal fire stripper

## 5G FTTH Drop cable

Caliber: 2mm x 1.6mm

## Both regular FTTH Drop cable

Caliber: 3mmx2mm

## Rotary ruler

## FTTH Drop cable steel wire pliers

Can not cut FRP steel wire/else steel wire  
Blade maybe will scratch and have trace,  
It's normal and will not influence you to use it  
If you are care about this, Then please buy with cautions.

## kevlar scissors

(prohibit cutting steel wires)

## Three-port Miller stripper

## Cleaning cotton



# 7800mAh lithium battery

## Dual charging path

In full state, 240 cores can be continuously fused and heated



**Charging time  $\leq 3.5$  hours**

# 15S automatic heating

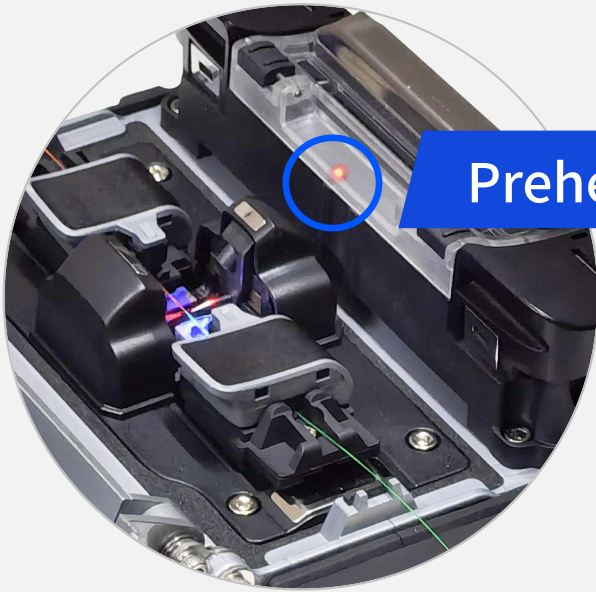

## Preheating

Successful fiber spliced. When opening the windproof cover to take out the fiber, the machine turns on pre heating for up to 6 seconds

## Heating part automatic lid closing

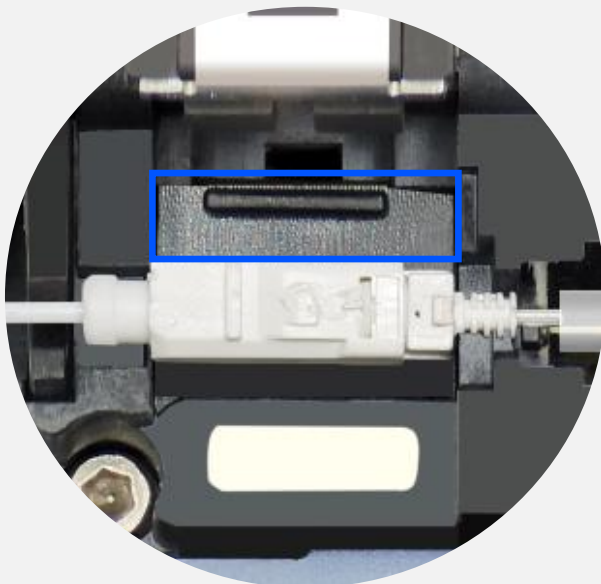
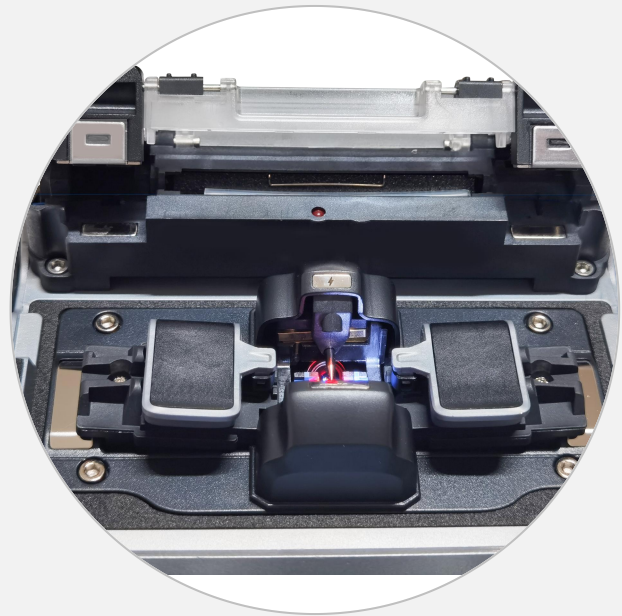

## Heating part compatible with SC fiber

SC Fiber: Push up

Ordinary fiber: Push down



# 3-IN-1 UNIVERSAL FIBER HOLDER



SM, MM, bare fiber, pigtail,  
Drop cable , multi fiber cable

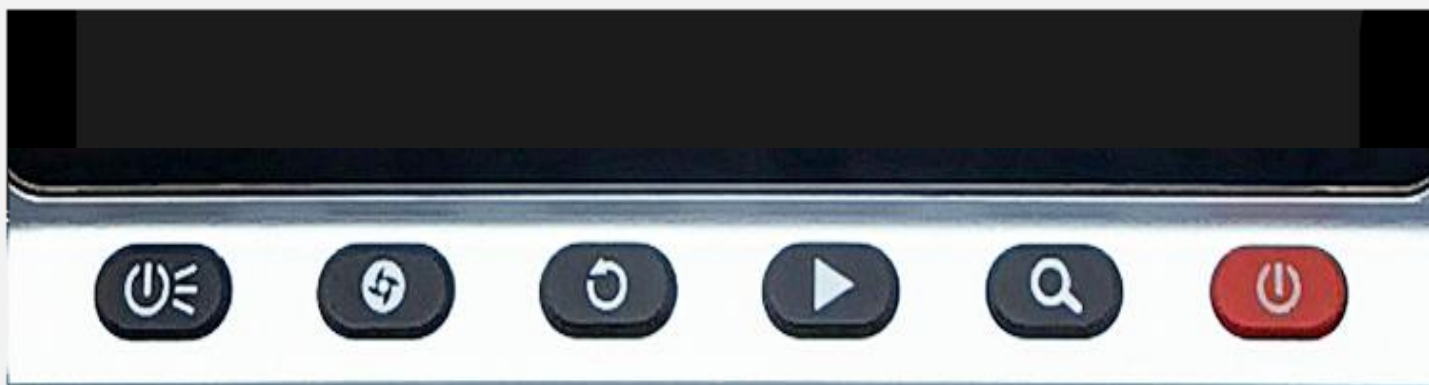
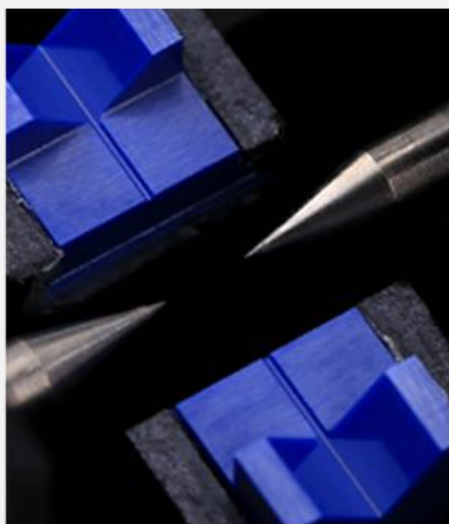

## EXQUISITE DETAILS

THE BUTTONS ARE CLEAR AND BEAUTIFUL



# COOLING RACK EXPANDABLE AND CLOSABLE



## ULTRA THICK PROTECTIVE RUBBER PAD

Thickened buffer structure  
provides maximum protection

# Outdoor fiber splicing Compact and portable



Bench+support platform



Compact and portable



Combination hanging chain  
Climbing homework



Compact and easy to carry

# 10 languages available

Multilingual Settings, covering the global market



**Chinese**



**English**

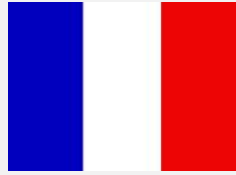

**French**



**Russian**



**Italian**



**Portuguese**



**Polish**



**Spanish**



**Thai**



**Arabic**

## Exported to nearly 100 countries and regions worldwide

Get unanimous praise from customers!



# Basic parameter

|                               |   |
|-------------------------------|---|
| <b>Fiber alignment</b>        | Core/cladding; Real-time luminous flux assisted alignment (Only applicable to environments with stable optical signal link from front)  |
| <b>Motor number</b>           | 6 motors<br><b>Accurate of fiber alignment :0.1μm</b>   |
| <b>Splicing time</b>          | 6s  |
| <b>Heating mode</b>           | 15s, can be customized according to the external environment  |
| <b>Fiber type</b>             | Single-mode fiber (SMF/G.652), BIF/G.657); Suitable for single mode, multi-mode, bare fiber, tail fiber, drop cable, jumper, invisible optical fiber.   |
| <b>The cladding diameter</b>  | 80-150μm  |
| <b>Splicing loss</b>          | 0.02dB (SM) 、 0.01dB (MM) 0.04dB (DS/NZDS)  |
| <b>Splicing mode</b>          | Automatic focusing core alignment, conventional/high precision splicing   |
| <b>Splicing way</b>           | Automatic, semi-automatic,manually  |
| <b>Fiber cleaver</b>          | High precision delay return electric one-step fiber cleaver   |
| <b>Fiber holder</b>           | Three in one fixture, no need to change, suitable for single/multi-mode, multi-core cable/bare fiber, tail fiber, jumper fiber,drop cable   |
| <b>VFL</b>                    | The machine comes with power: 15mW, 2Hz flashing and steady on mode   |
| <b>OPM</b>                    | Wavelength: 850nm、 1300nm、 1310nm、 1490nm、 1550nm、 1625nm、 980nm、 1270nm、 1577nm、 1650nm/Measurement range: -50+30dbm Absolute error: <0.3dB (-50dbm ~+3dBm range)  |
| <b>Battery capacity</b>       | 7800mAh large capacity lithium battery charging time ≤3.5 hours; It can continuously weld and heat about 240 cores  |
| <b>Magnification</b>          | 320x (X or Y axis single display) , 200x (x and Y axis dual display)  |
| <b>Fiber diameter</b>         | Coating diameter: 80-150μm/Coating diameter: 100-1000μm   |
| <b>Cutting length</b>         | Coating layer 250μm below: 8-16mm/coating layer 250-1000μm: 16mm  |
| <b>Heat shrink tube</b>       | 60mm、 50mm、 40mm、 25mm  |
| <b>Tensile testing</b>        | standard 2N   |
| <b>display</b>                | 5 inch TFT color display screen   |
| <b>Boot time</b>              | 1s, boot can enter the working mode   |
| <b>Data is stored</b>         | Unlimited, machine storage 1000 groups, the excess part can be stored in the server, can export data.   |
| <b>Wireless communication</b> | Based on bluetooth 4.2 protocol standard, the working band is 2.4GHz, the maximum transmission range is 60m   |
| <b>Software upgrade</b>       | Mobile phone APP Internet update, enable Bluetooth synchronization upgrade machine software   |
| <b>Management function</b>    | The equipment owner can be bound as the highest authority, and can remotely view the splicing records, splicing time, loss, etc. through the mobile phone APP. The number of splicing times or working time of the equipment can be set. The manager can effectively manage a single or multiple equipment. |
| <b>Return loss</b>            | Better than 60 db   |
| <b>Product protection</b>     | Waterproof, dustproof and fall proof  |
| <b>Power supply</b>           | Input AC100-240V 50/60Hz, output DC13.5V/4.8A, the current power mode can be identified, real-time monitoring of the current battery level  |
| <b>The work environment</b>   | Temperature: -15 ~ +50°C, humidity: < 95%RH (no condensation), working altitude: 0 ~ 5000m, maximum wind speed: ≤15m/s  |

# Accessories in the tool box



- ① Toolcase
- ② Fusion splicer
- ③ Spare electrode
- ④ signal fire stripper  
(Including a bag of cleaning cotton)
- ⑤ Alcohol bottle
- ⑥ Cleaver cleaning cotton swab
- ⑦ Allen wrench
- ⑧ Brush
- ⑨ Climbing combination hanging chain
- ⑩ Toolbox strap
- ⑪ Belt
- ⑫ Power adapter
- ⑬ User's manual / Quality Certificate / Warranty Card / Fiber for ARC

## Size and weight



### Machine size

165mm x 255mm x 185mm

### Machine weight

3.09kg



### Toolbox size

165mm x 255mm x 230mm

### Weight of toolbox

**(complete set)** 4.50kg



### Total size

340mm x 255mm x 325mm

### Total weight

5.50kg

## SERVICE COMMITMENT

**Five years warranty, but these circumstances are not within the scope of this provision.**

**01.** Except for the cleaver, Signal fire stripper, fiber holders and other tools whose life depends on the frequency of use and the use of the environment. Also electrodes are consumption material which are not in the warranty.

**02.** Battery and power adapter are warranty for one year, it is in free warranty where it is damaged or can not be charged in one year.

**03.** Electrodes are consumables, the service life of each pair of electrode is 4000 times.



## Bluetooth Connection

Establishing wireless communication through Bluetooth technology to achieve data transmission



- Welding record can be read through mobile phone, and the data can be exported;
- You can set the parameters of the welding machine, such as selecting the machine language, changing the heating time, selecting the fiber optic alignment mode, etc;
- You can manage the welding machine, such as setting the use time of the machine, welding times, etc;
- Upgrade the phone APP, bluetooth connected to the machine to upgrade the machine software;

# Intelligent interaction, avoid tedious

Scan the QR code of the welding machine startup screen to download the Mobile APP. The phone connects to the splicer via Bluetooth.

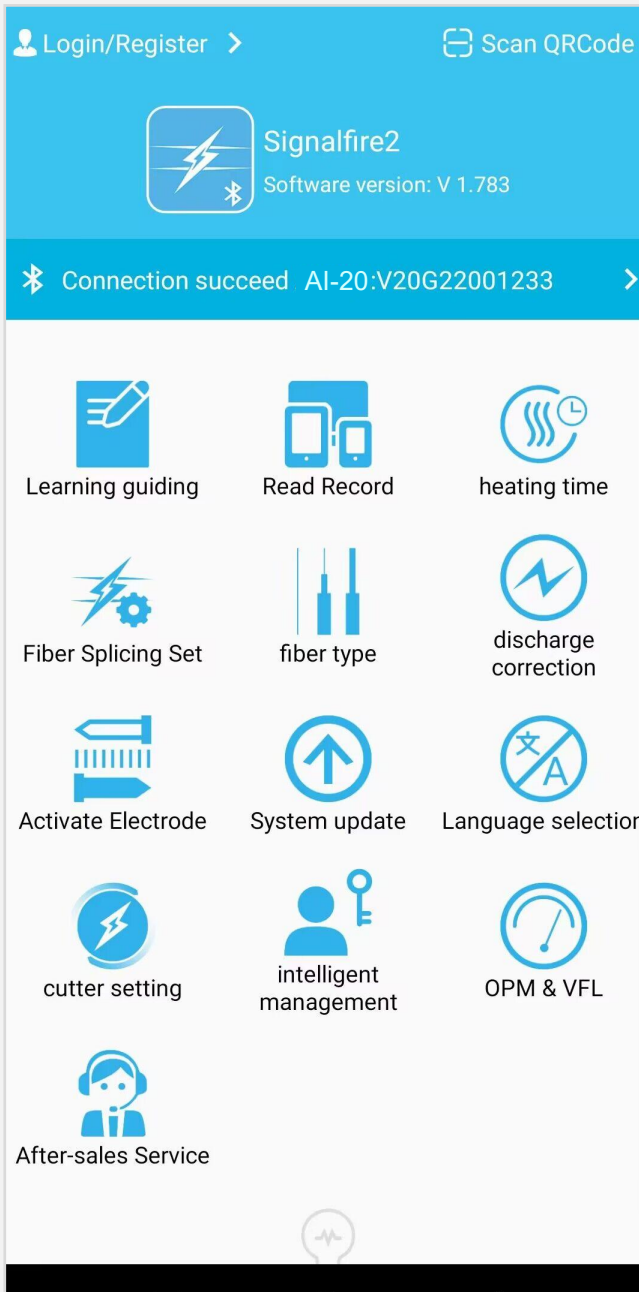

APP main interface

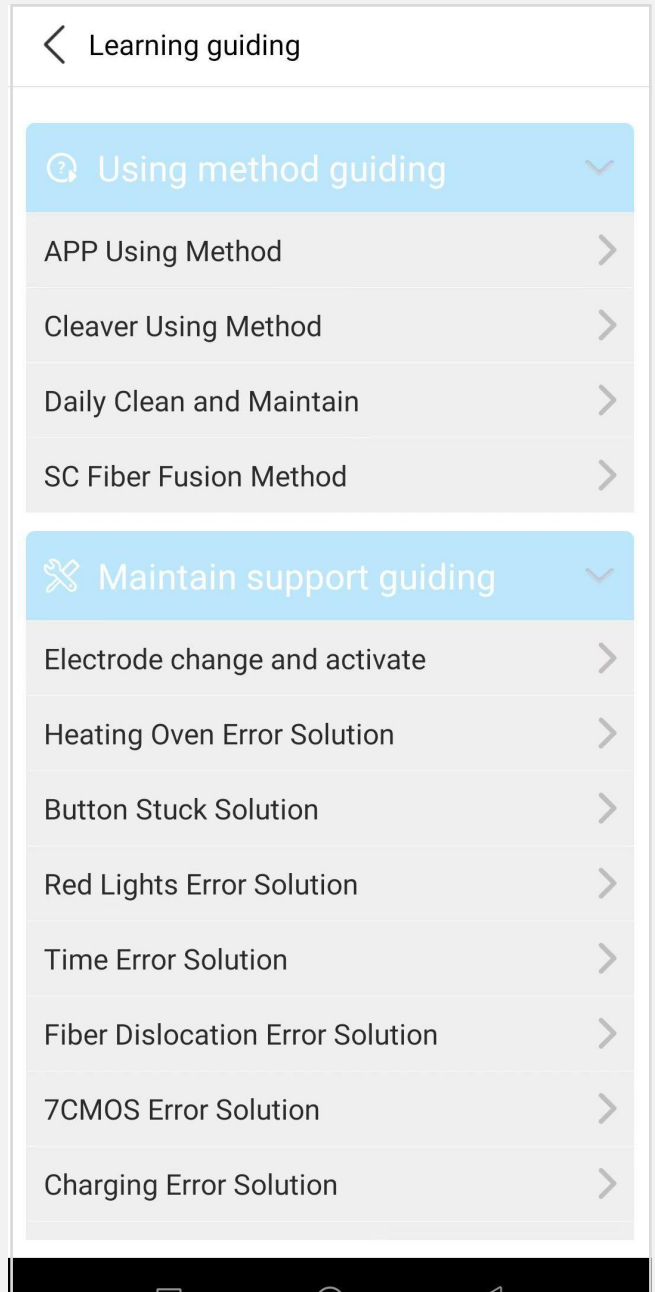

Learning guidance interface



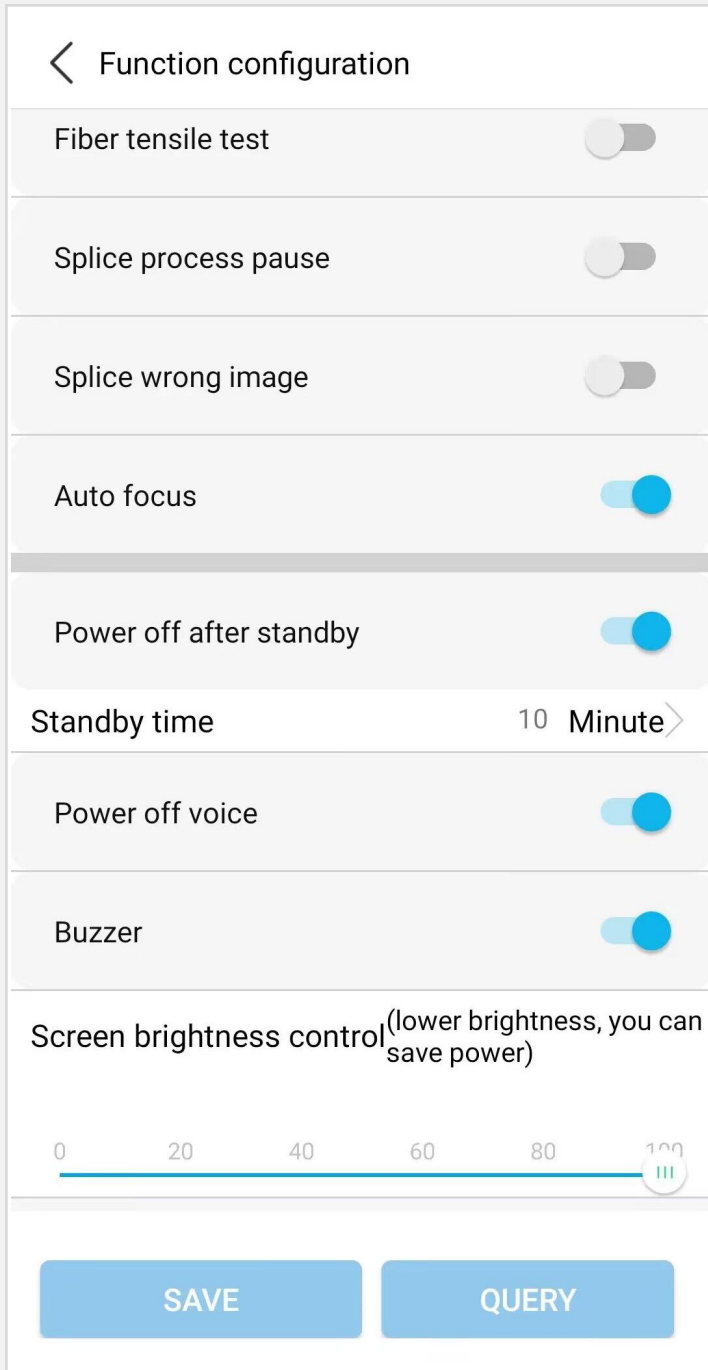

### Energy saving mode

Automatic shutdown of the machine without any action within the set time

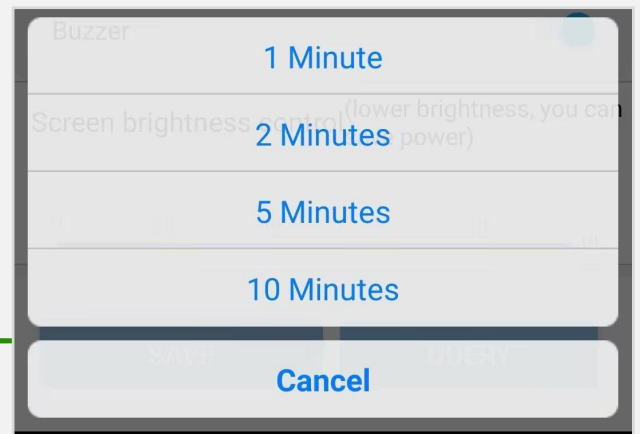

After it is opened, there will be voice prompt in the whole process from fiber laying, fiber matching, welding and loss value. In case of unqualified items, it will be directly informed.

Adapt to bright light, dark and other different outdoor environment

Splicing record More

Cumulative fusion times: 0 times

Machine: AI-20 :V20G22001233

Specify user: all

View by time: 4 times

2024-09-01 - 2024-09-30

| serial number | Splicing loss | Time                | Weld image |
|---------------|---------------|---------------------|------------|
| 1             | 0.00          | 2024-09-30 18:43:39 |            |
| 2             | 0.01          | 2024-09-30 18:42:33 |            |
| 3             | 0.01          | 2024-09-30 18:41:25 |            |

**Splicing records can be downloaded and exported**

Unlimited storage of splicing records  
Can be viewed on mobile devices

heating time

Pre-heat model

Choose shrinkable tube Customize >

Set heating time  s

Preheating mode: The welding is completed. When the windshield is opened, the heater is heated in advance for 6 seconds. Turning on the preheating mode can appropriately reduce the heating time of the heat shrinkable tube to improve efficiency.

Note: In winter or low temperature, heating is not ideal, and the heating time can be

**Heating time customization**

Extreme cold/high temperature can be extended or shortened appropriately

Unconnected device >

|           |   |
|-----------|---|
| 中文 (简体)   | Auto-detection                              |
| English   | English <input checked="" type="checkbox"/> |
| Português | Русский                                     |
| Français  | Español                                     |
| Русский   | Italiano                                    |
| Español   | Português (Brasil)                          |
| Polski    | Português                                   |
| ไทย       | Indonesia                                   |
| عربي      | Polski                                      |
| Italiano  | Français                                    |
|           | عربي  |

**Fusion splicer language/  
mobile app selection**

cutter setting System parameters

Cutting length: 13.0mm >

Cutting type: Automatic identification >

Automatic cutting: OFF  ON

Replace the blade >

Tension automatic correction  
This function can be turned off when the automatic correction function is turned on and the ideal cutting length cannot be reached. ON  OFF

LED brightness adjustment

Cutter usage tutorial >

Common problems and solutions >

Clean cutter >

Factory settings >

Cutting times:72

**Cleaver Parameter setting  
/adjustment**



Signal Fire Technology Co., Ltd. is a high-tech joint-stock enterprise specializing in the research and development, production, and sales of communication equipment, with a registered capital of 10 million. It is a national high-tech enterprise. Our main products include fiber optic fusion splicers, electric fiber cleaver, OTDR (Optical Time Domain Reflectometer), and 9-in-1 optical fiber stripper. They are widely used in the construction, maintenance, emergency repair, security monitoring, and research and teaching of optical cable lines in telecommunications, mobile, China Unicom, radio and television operators, post and telecommunications, railway, engineering companies, and public institutions.





The factory is located in Chengdu High tech International Enterprise Port, with a modern production factory and standardized office buildings. We have passed the ISO9001 international quality management system certification, and our products have passed the EU CE, ROHS. International certifications such as FCC in the United States and UKCA in the United Kingdom have been passed by the National Institute of Quality Supervision and Inspection, China Academy of Information and Communications Technology.







The qualified testing of Taier Laboratory has obtained nearly a hundred domestic and international patents at the same time. The "Signal Fire" series products have been sold to over 100 countries and regions including North America, South America, Europe, Africa, and Asia, and have received unanimous praise from customers.

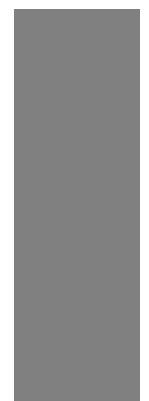

# Operator winning bid brand



Telecom installation and maintenance skills competition, Signal fire fusion splicer excellent performance, won the group first prize



# Exhibition photos

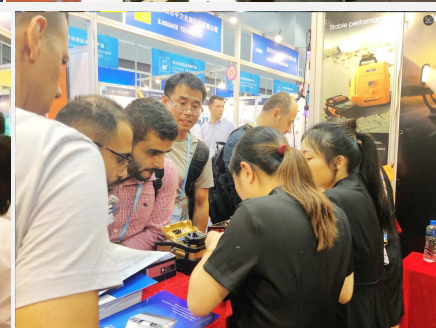
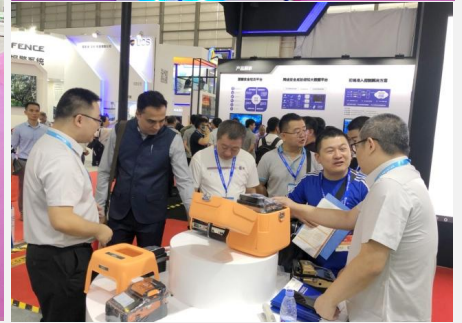



# Intellectual property

Signal Fire Technology Co., Ltd. has passed the ISO9001 international quality management system certification. The product has passed international certifications such as the CE, RoHS, the United States FCC, and UKCA in the United Kingdom, and passed the qualified test through National Quality Supervision Institute, China Xintong Institute, and Tel Laboratory. At the same time, we obtained nearly 100 patents.

CERTIFICATE



**CERTIFICATE**  
Of Conformity  
Directive 2014/53/EU  
On The Radio Equipment Directive

**Certificate No.:** AT18220WC202819  
**Certificate Holder:** SIGNAL FIRE TECHNOLOGY CO., LTD.  
**Address:** Building 18, Chengdu Hi-Tech International Enterprise Park, Liando U Valley, 1111 Changsheng Bridge, Pidu District, Chengdu, China  
**Manufacturer:** SIGNAL FIRE TECHNOLOGY CO., LTD.  
**Address:** Building 18, Chengdu Hi-Tech International Enterprise Park, Liando U Valley, 1111 Changsheng Bridge, Pidu District, Chengdu, China  
**Product Name:** OPTICAL FIBER FUSION SPLICER  
**Model No.:** AI-9, AI-6C, AI-6V, AI-7C, AI-8C, AI-8X, AI-7V, AI-X, S9  
**Trade Mark:** Signal fire  
**Rating:** Input: 13.5V/4.8A DC (with DC 11V, 7800mAh Battery inside)

| The radio equipment meets the following essential requirements | Complied |
|--|----------|
| Article 3(1)(a) Safety   | Yes      |
| Article 3(1)(b) Health   | Yes      |
| Article 3(1)(b) EMC  | Yes      |
| Article 3(2) Radio   | Yes      |

Note: The attached Annex forms part of this certificate which consists of 2 pages.

**CE** The CE Marking may only be used if all relevant and effective EU Directives are complied with **CE**

Shenzhen Anbotek Compliance Laboratory Limited  
1/F, Building D, Sogood Science and Technology Park, Sanyue community, Hangsheng Street, Bao'an District, Shenzhen, Guangdong, China 518128  
Tel: (86)755-26066440 Fax: (86)755-26014772  
Http://www.anbotek.com Email: service@anbotek.com

**UKCA** The UKCA Marking may only be used if all relevant and effective UK Regulations are complied with **UKCA**

Shenzhen Anbotek Compliance Laboratory Limited  
1/F, Building D, Sogood Science and Technology Park, Sanyue community, Hangsheng Street, Bao'an District, Shenzhen, Guangdong, China 518128  
Tel: (86)755-26066440 Fax: (86)755-26014772  
Http://www.anbotek.com Email: service@anbotek.com

CERTIFICATE

CERTIFICATE



**CERTIFICATE**  
Of Conformity  
Radio Equipment Regulations 2017  
(SI 2017 No. 1206)

**Certificate No.:** AT18220WC202820  
**Certificate Holder:** SIGNAL FIRE TECHNOLOGY CO., LTD.  
**Address:** Building 18, Chengdu Hi-Tech International Enterprise Park, Liando U Valley, 1111 Changsheng Bridge, Pidu District, Chengdu, China  
**Manufacturer:** SIGNAL FIRE TECHNOLOGY CO., LTD.  
**Address:** Building 18, Chengdu Hi-Tech International Enterprise Park, Liando U Valley, 1111 Changsheng Bridge, Pidu District, Chengdu, China  
**Product Name:** OPTICAL FIBER FUSION SPLICER  
**Model No.:** AI-9, AI-6C, AI-6V, AI-7C, AI-8C, AI-8X, AI-7V, AI-X, S9  
**Trade Mark:** Signal fire  
**Rating:** Input: 13.5V/4.8A DC (with DC 11V, 7800mAh Battery inside)

| The radio equipment meets the following essential requirements | Complied |
|--|----------|
| CHAPTER 1 (General)(a) Safety                                  | Yes      |
| CHAPTER 1 (General)(1)(a) Health                               | Yes      |
| CHAPTER 1 (General)(1)(b) EMC                                  | Yes      |
| CHAPTER 1 (General)(2) Radio                                   | Yes      |

Note: The attached Annex forms part of this certificate which consists of 2 pages.

**UKCA** The UKCA Marking may only be used if all relevant and effective UK Regulations are complied with **UKCA**

Shenzhen Anbotek Compliance Laboratory Limited  
1/F, Building D, Sogood Science and Technology Park, Sanyue community, Hangsheng Street, Bao'an District, Shenzhen, Guangdong, China 518128  
Tel: (86)755-26066440 Fax: (86)755-26014772  
Http://www.anbotek.com Email: service@anbotek.com

CERTIFICATE

**TCB** GRANT OF EQUIPMENT AUTHORIZATION **TCB**

Issued Under the Authority of the Federal Communications Commission

By: Ray Area Compliance Laboratory Corp. Date of Grant: 02/09/2018  
1274 Ansheng Road Sanyue, CA 94388 Application Date: 02/09/2018

Signal Fire Technology Co., Ltd.  
No. 184 Qingyang Zone, Jiansheng Industrial Park  
Qingyang District, Chengdu, China  
Attention: Jason Yang

**NOT TRANSFERABLE**

EQUIPMENT AUTHORIZATION is hereby issued to the named GRANTEE, and is VALID ONLY for the equipment identified hereon for use under the Commission's Rules and Regulations listed below.

FCC IDENTIFIER: A23911739  
Name of Grantee: Signal Fire Technology Co., Ltd.  
Equipment Class: Digital Transmission System  
Notes: OPTICAL FIBER FUSION SPLICER

| Grant Notes                        | FCC Rule Parts | Frequency Range (MHz) | Output Watts | Frequency Tolerance | Emission Designator |
|------------------------------------|----------------|-----------------------|--------------|---------------------|---------------------|
| Output power listed is controlled. | 15C            | 2402.0 - 2483.0       | 0.3004       |                     |                     |





**QUALITY MANAGEMENT SYSTEM CERTIFICATE**

Certificate No.: 11423Q45347R2M

This is to certify that the Quality Management System of

**SIGNAL FIRE TECHNOLOGY CO., LTD.**

Unified Social Credit Code: 9151010007241028D

Registered Address: No. 1111 Changsheng Bridge, Hongqiang Town, Small and Micro Enterprise Innovation Park, North Area of Chengdu Modern Industrial Park, Pidu District, Chengdu  
Production Office Address: Building 18, Chengdu High-tech International Enterprise Park, Liando U Valley, No. 1111 Changsheng Bridge Road, Pidu District, Chengdu City, Sichuan Province, China

Has been audited to conform to the following Quality Management System standard

**GB/T19001-2016/ISO9001:2015**

The Applicable Scope

The production of optical fiber fusion splicer

Date of initial issuance: Aug. 22, 2017  
Date of issuance: Jul. 11, 2023  
Date of expiry: Jul. 21, 2025

Issued by: *Wei Fengyu* Beijing East Allreach Certification Center Co., Ltd.





The certificate will remain valid only if the certified organization accepts surveillance audit as regular intervals and notified in accordance with the conditions available at EACC website [www.eacc.com.cn](http://www.eacc.com.cn) and a label available by scanning the QR Code on the lower right corner.  
Address: 1st Floor, No. 122 Building, No. 11, Jingchengmen Street, Jiqiao Science & Technology Incubator, Jinqiao Science Park of Chengde Science & Technology Park, Tangshan District, Hebei 054002

